

# VERWERKINGSVOORSCHRIFTEN

## OBI 100-300 HOEKEN

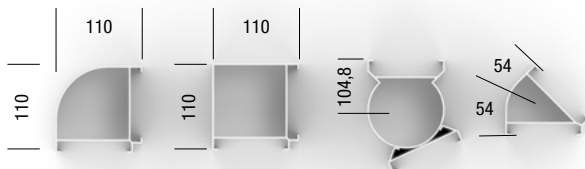

**90° AFGEROND**  
**90° ROUNDED**



**90° RECHT**  
**90° STRAIGHT**



**FLEXHOEK**  
**FLEX CORNER**



**135° HOEK**  
**135° CORNER**

1

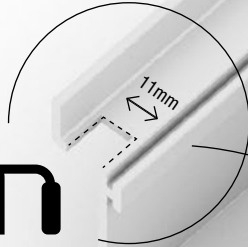
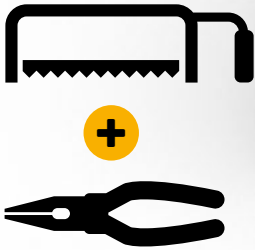

2x

9mm



**NL** Bij onvoldoende instansingen kunt u deze **zelf inzagen**.

Standaard is elk vloerprofiel aan 1 zijde voorzien van 2 instansingen.

**EN** If there are not enough punches, you can **cut them yourself**.

Each floor profile comes with 2 punches on one side.

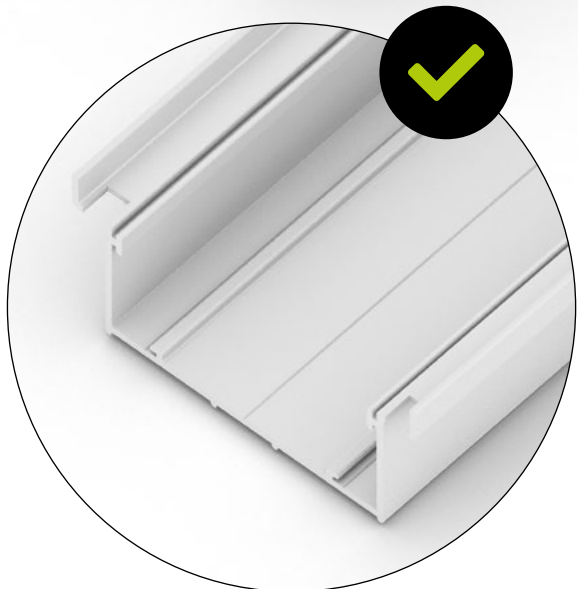

2

**NL** Plaats de voetsteun in het hoekprofiel vóór u het vloerprofiel tegen het hoekprofiel schuift.

**EN** Place the footrest in the corner profile before you slide the floor profile against the corner profile.

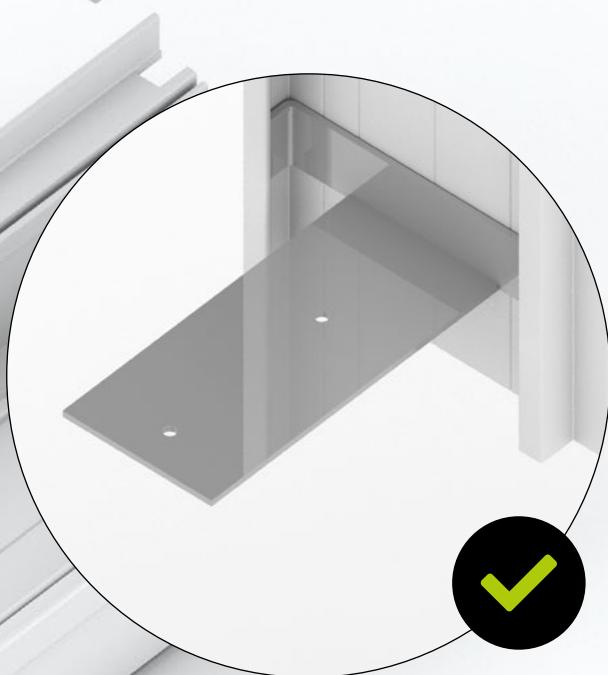
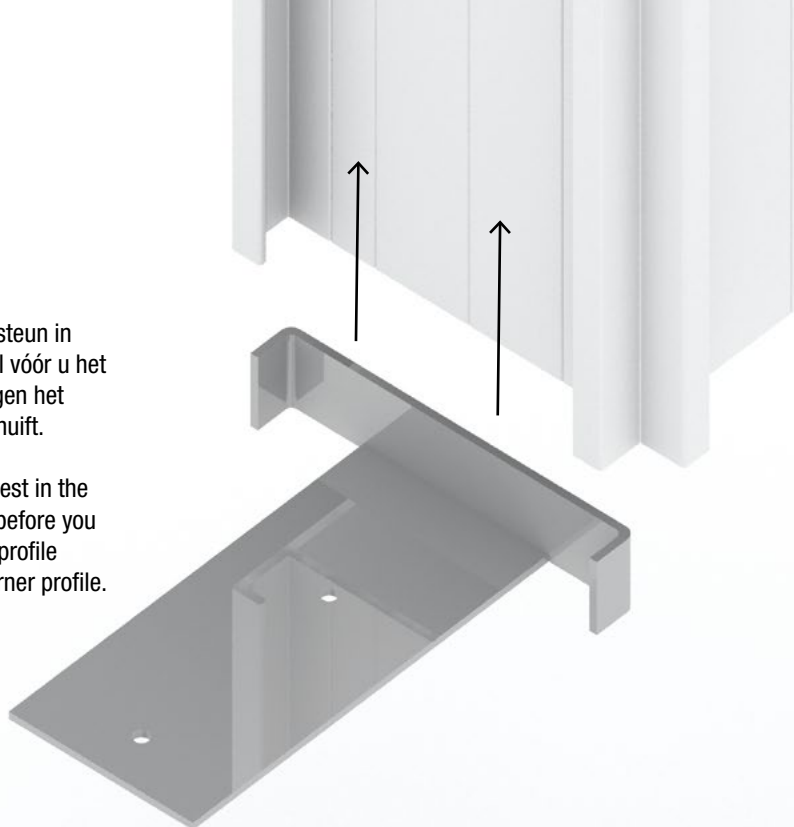

3



NL

Schuif het vloerprofiel tegen het hoekprofiel en schroef de voetsteun door het vloerprofiel.

EN

Slide the floor profile against the corner profile and screw the footrest through the floor profile.

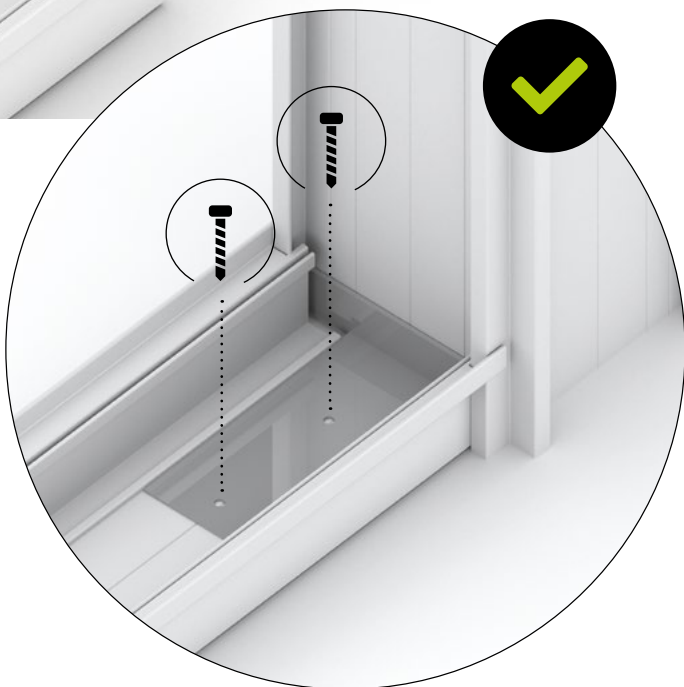

4

9 mm



NL

Ook voor het  
plafondprofiel  
dient een inkeping  
aangebracht te worden,  
als deze nog niet  
aangebracht is.

EN

A notch should also be  
provided for the ceiling  
profile, if it is not  
already applied.

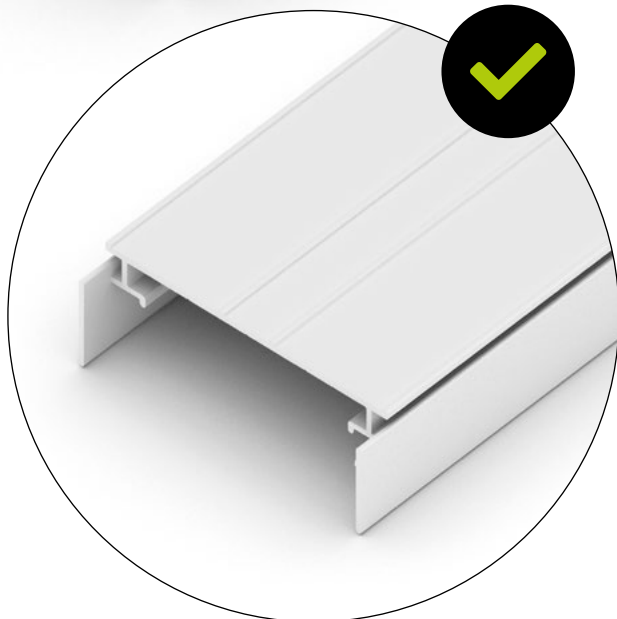

5

**NL** Schuif het plafondprofiel tegen het hoekprofiel en schroef de voetsteun door het plafondprofiel.

**EN** Slide the ceiling profile against the corner profile and screw the foot support through the ceiling profile.

